

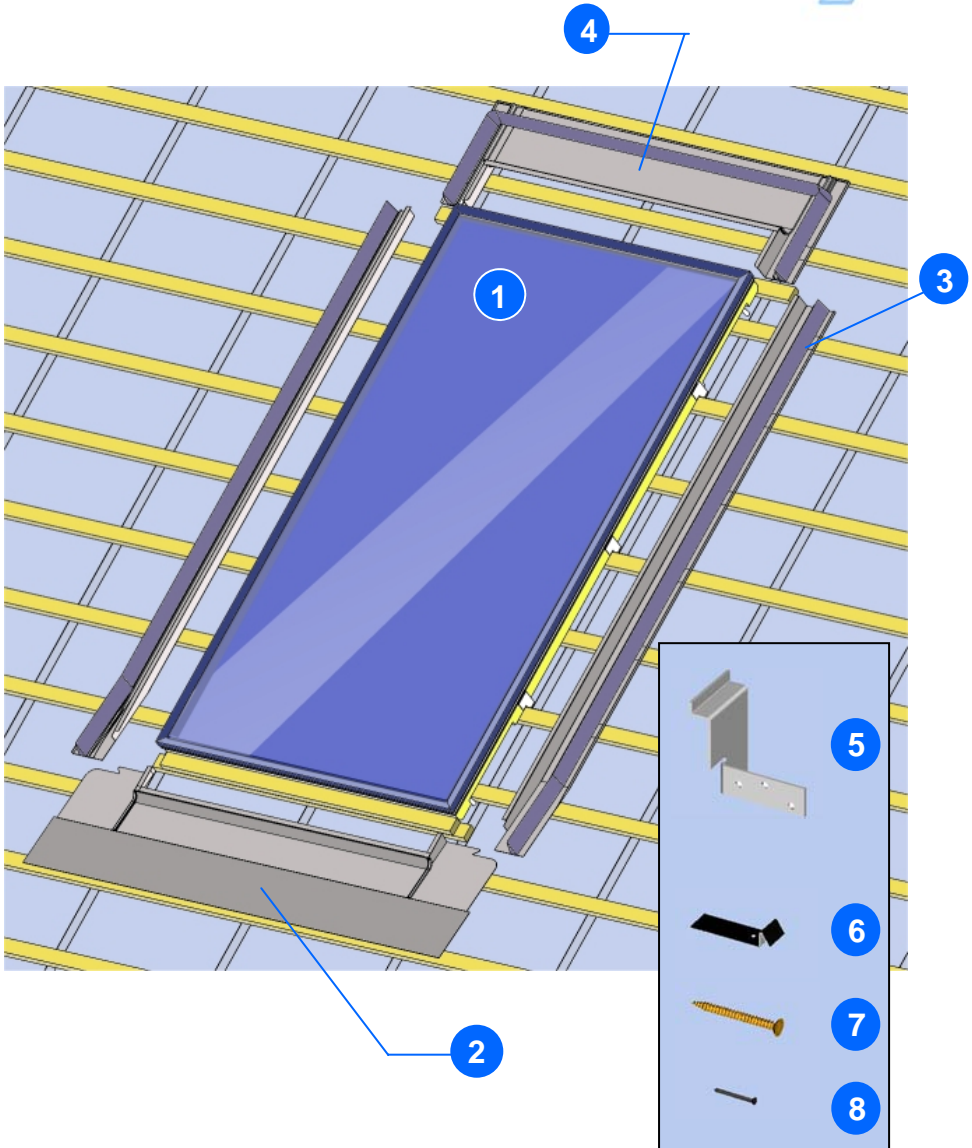

Clearline®

Roofing Installation





Contents

| | V15 | V20 | V30 |
|--------------------------------|-----|-----|-----|
| 1 Solar Panel | 1 | 1 | 1 |
| 2 Sill Flashing | 1 | 1 | 1 |
| 3 Side Flashing | 2 | 4 | 4 |
| 4 Top Flashing | 1 | 1 | 1 |
| 5 Panel Fixing Brackets | 4 | 4 | 6 |
| 6 Flashing Fixing Tabs | 10 | 12 | 18 |
| 7 4 x 50mm Screw | 8 | 8 | 12 |
| 8 25mm Nail | 10 | 12 | 18 |

1

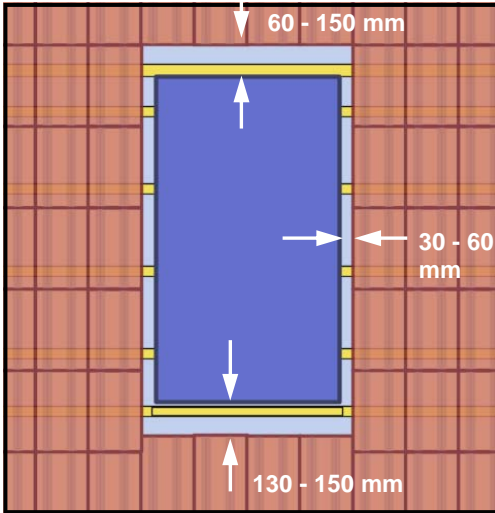

Setting Out

2

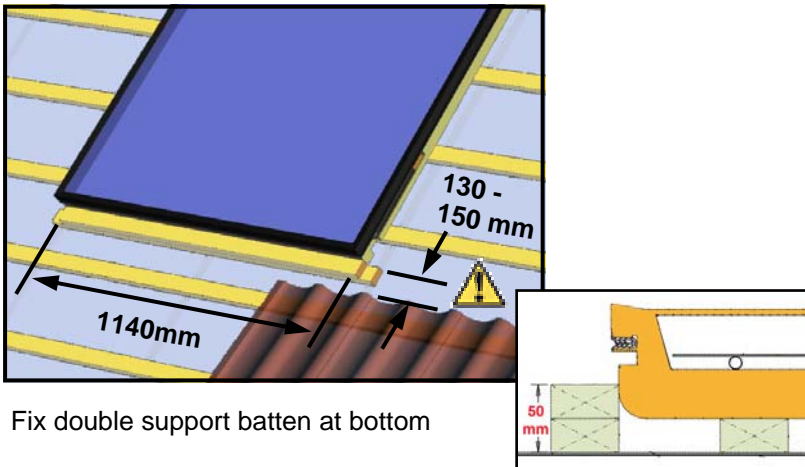

Fix double support batten at bottom

3

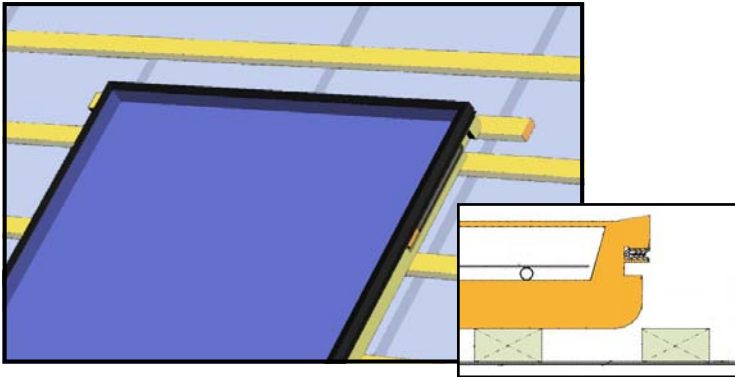

Fix support batten at top

4

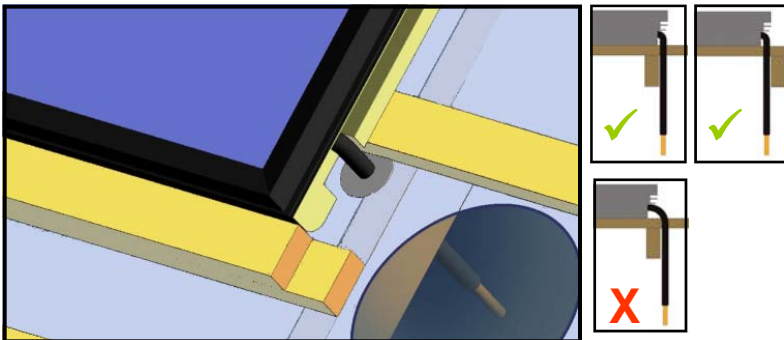

Position panel to avoid rafters. Pass flexible hoses through membrane. Tape around hose to seal membrane. If avoiding batten, take hose downhill.

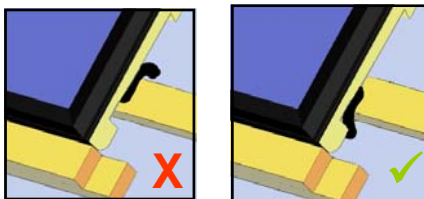

5

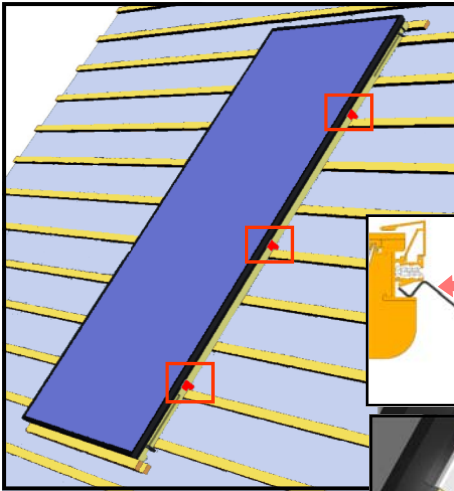

Attach panel fixing brackets to sides of panel using 2 screws per bracket.

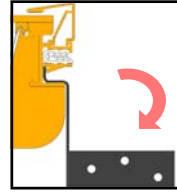
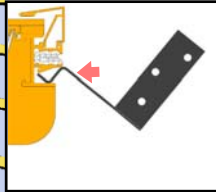

6

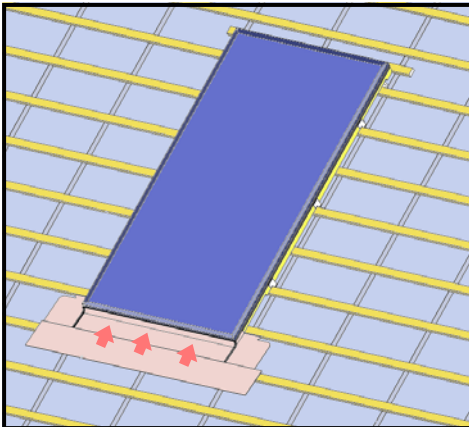

Push sill flashing into rubber seal at bottom of panel.

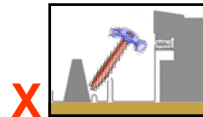
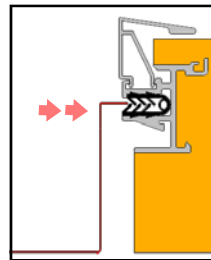

7

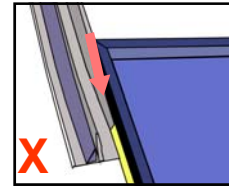
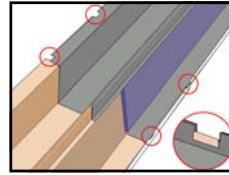
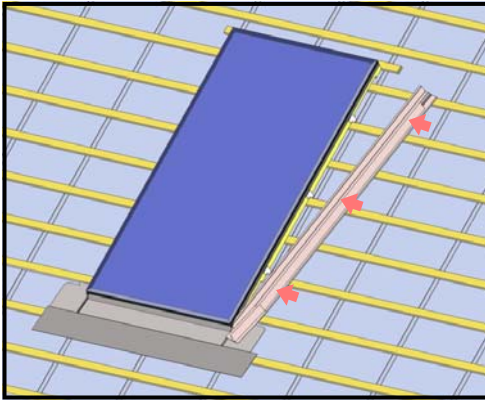

Join side flashings if in two pieces (V20, V30) using tabs provided. Push side flashings into side seal. Do not attempt to slide from top

8

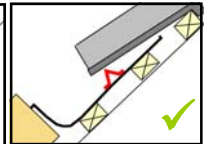
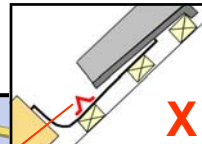
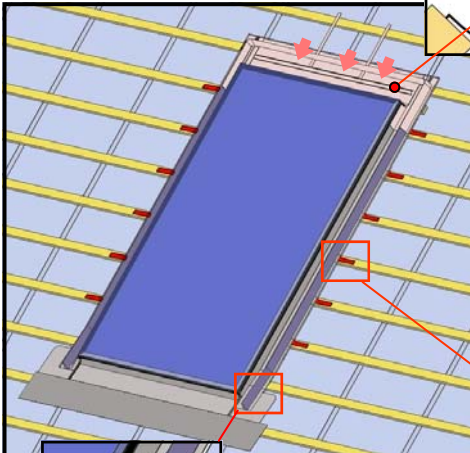

Push top flashing into seal. Secure side flashings to tile battens with flashing tabs. Tile around. Dress lead into tiles using lead mallet. Treat lead with patination oil.

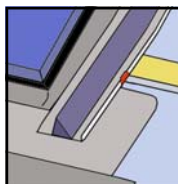
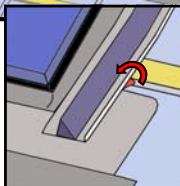
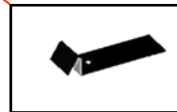



Viridian Solar

Viridian Solar
Brook Lane
Bassingbourn
Cambridgeshire.
SG8 5NT

T 01763 853 007
F 01763 853 001

support@viridiansolar.co.uk
www.viridiansolar.co.uk

